

Ready2Connect[®] HOT RUNNER SYSTEMS

Install, connect and get started



Fully assembled systems available as ready-to-install solutions

Save time and costs with a fast, simplified installation and safe commissioning. We handle the wiring and ensure that the electrics function correctly. This prevents any wiring faults and a stable manufacturing process is assured from the outset.

The advantages at a glance

- + Ready-to-install solution
- + Fast, safe commissioning
- + Simplified project planning
- + Extended warranty conditions

16-drop open hot runner system with BlueFlow® nozzles type 5SHF

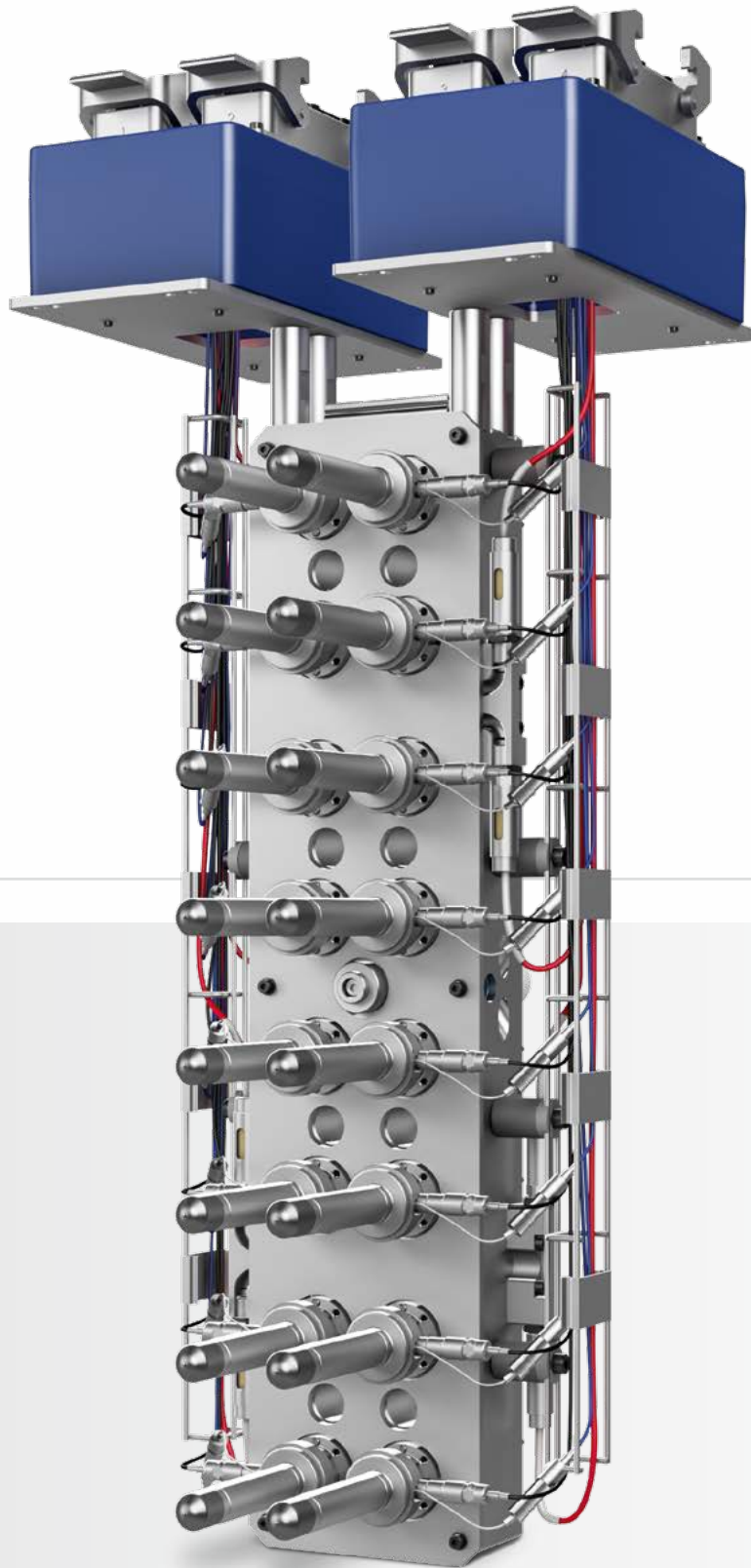



Special features

The wire cable tray that we use reliably protects cables against crushing. All cables and plug connections are easily accessible and hot spots are safely avoided. Our installation-friendly cable boxes are wired in a clearly arranged structure and configured as per your requirements.

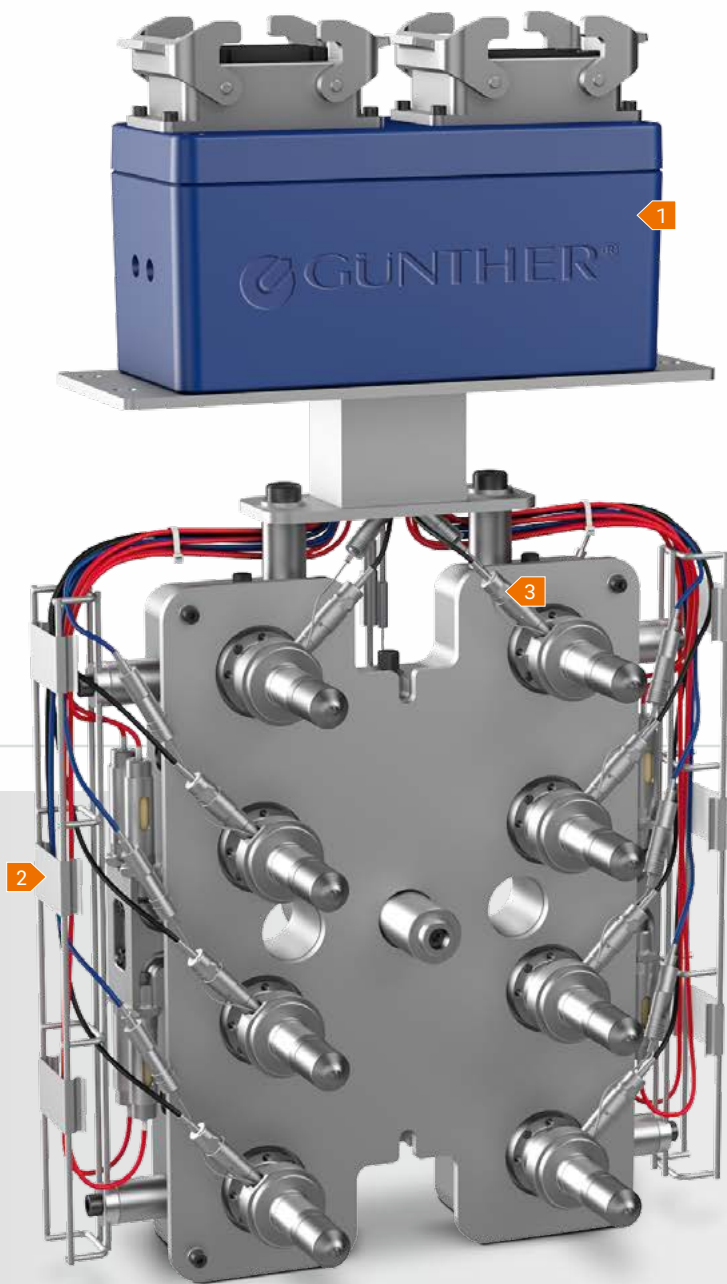

1 Standardized cable boxes

- Suitable for any cavitation with your chosen plug/socket configuration
- Tidy wiring thanks to terminal blocks
- Installation-friendly and clearly arranged
- Optimally safe thanks to protective conductor terminal
- Pre-wired on terminal strips in compliance with EN 60204-1
- Connection from the terminal strips using the connector designs required by the customer

Thanks to the clearly arranged wiring via terminal blocks, defined measurement points are available for all load contacts, making it easier to carry out checks at a later stage.



8-drop open hot runner system with BlueFlow® nozzles type 5SHF



2 Wire cable tray

- Routes cables and plug connections safely
- Freely accessible connections
- No hot spots thanks to wire structure



3 Power connection

- High-temperature flame retardant
- Simple interlock
- Secure locking thanks to push/pull mechanism
- Installation-friendly

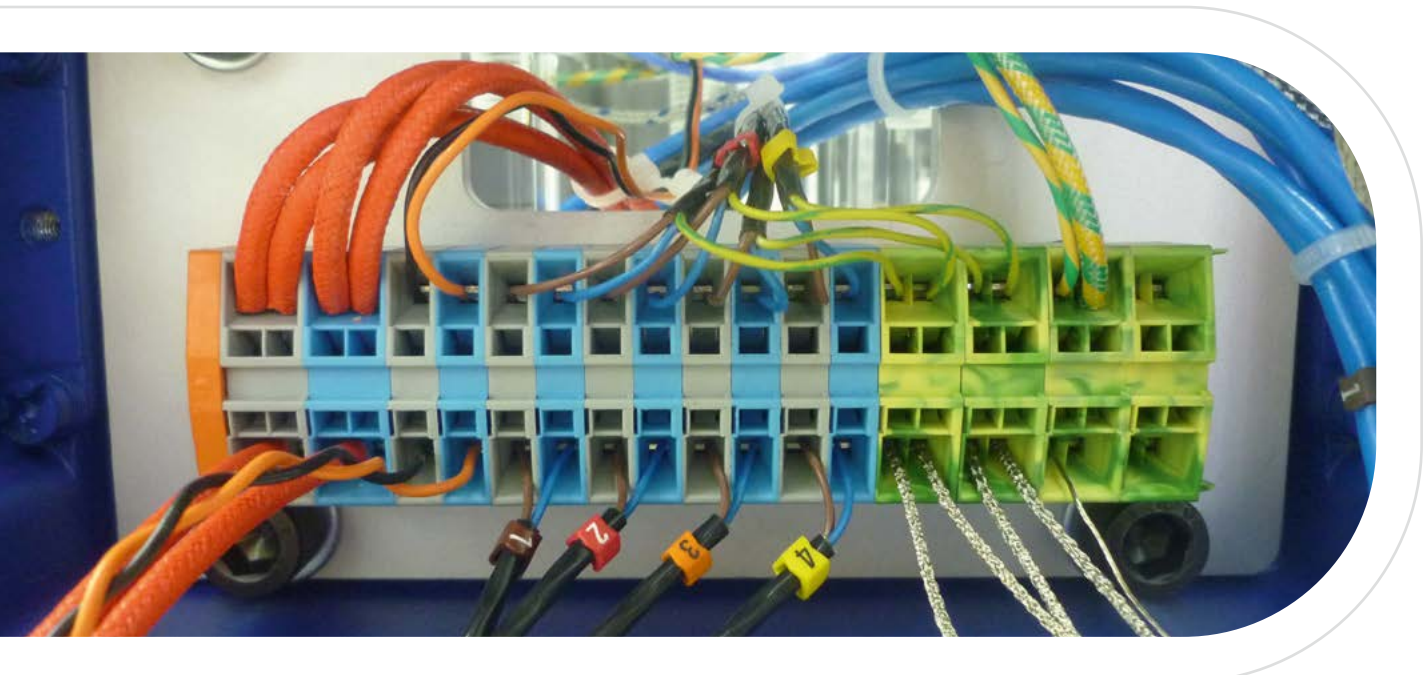



You decide

As you'd expect, we supply our Ready2Connect® systems as both open hot runner and valve gate systems. All you need to do is install a suitable drive and the needle actuators.

1 Cylinder for the lifting plate

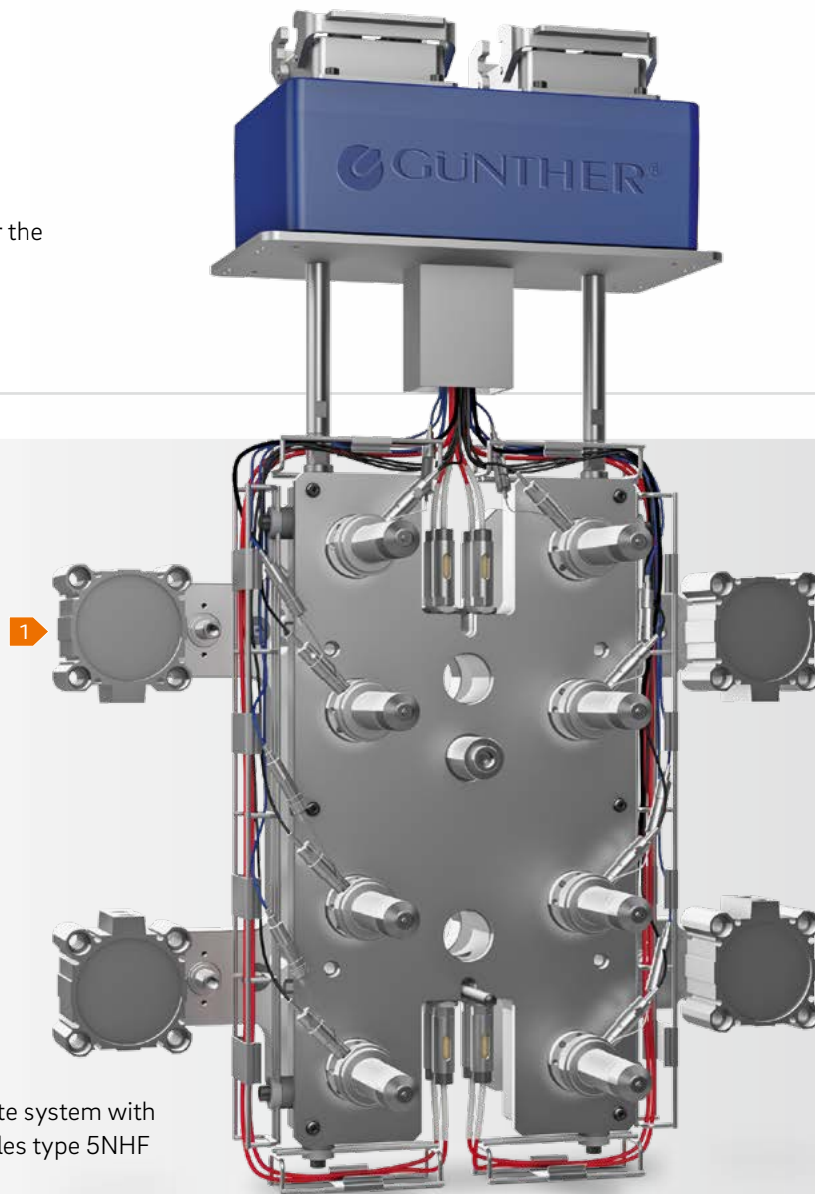

8-drop valve gate system with BlueFlow® nozzles type 5NHF and lifting plate



Leak protection

Our hot runner nozzles guarantee reliable leak protection thanks to the two-part nozzle shaft. Leaks caused by frequent mounting and removal are thus a thing of the past.

Screwed onto the manifold only lightly, the nozzles position themselves automatically during the heating process. This means the system does not bow and no minimum nozzle lengths are required.

1 Leak protection and optimal thermal separation thanks to our patented two-part shaft.

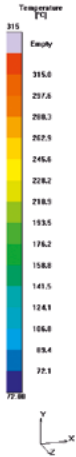
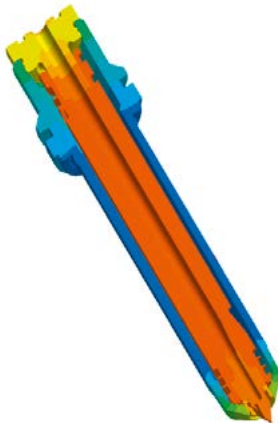
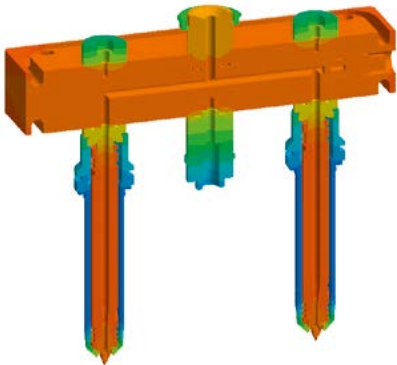

3D simulation of hot runner systems

When planning and designing our hot runner systems, we use our established, yet pioneering technology and ensure optimum temperature control throughout the entire hot runner system thanks to our many years' experience and the option of simulations. In doing so, we take the entire flow path into account – from the connecting nozzle and the manifold through to the nozzles and into the cavity.

With the aid of 3D simulation, we detect any hot or cold spots early on at the design stage. The simulation of several complete injection moulding cycles allows us to guarantee an optimal thermal design before we start to manufacture the hot runner system.

All systems contain:

- High-grade components for a long service life
- Perfectly matched to one another
- Complete systems – from simple to complex

GÜNTHER assists its customers:

- Comprehensive consultation during design
- Support during project planning
- Engineering for custom-fit interfaces
- Ready-to-install system custom-made to customer requirements



Would you like to benefit
from the advantages of our
Ready2Connect® systems?

If so, contact your sales representative or contact
our Technical Application Consultation Service on

- + Telephone: +49 6451 5008-510
- + E-mail: atb@guenther-heisskanal.de

GÜNTHER Heisskanaltechnik GmbH

Industriepark Nord | Sachsenberger Strasse 1 | 35066 Frankenberg (Eder), Germany

T +49 6451 5008-0 | F +49 6451 5008-50

info@guenther-heisskanal.de | www.guenther-hotrunner.com

 **GÜNTHER**[®]
HOT RUNNER TECHNOLOGY